











- 
Scan & Smile
- 
DHC Library
- 
Scan Bridge
- 
Guided Surgery
- 
Tooth-in-a-Box
- 
Lab Design
- 
Lab Milling
- 
LMS

matrix[®] **SYS-TEM**
LINE OVERVIEW



matrix®

100%
DIGITAL

NO
ABUTMENT.
NO
CEMENT.
NO
LIMITS.

THE WORLD'S FIRST **DIGITAL** **IMPLANT**

The **matrix**® is the first-ever dental implant connection that has been specifically designed for the new digital manufacturing technologies such as CAD/CAM milling or 3D printing. The implant concept allows to plan the restoration directly on the implant without the use of the abutment and without manual cementation.

8 digital **matrix**® applications allow an immediate access to fast, precise and profitable clinical workflows - eliminating the need for an abutment.



8 unique
patents



8 integrated apps for
the digital workflow



CE & FDA
Registered



Red Dot Awards
winner

EXPLORE THE BENEFITS

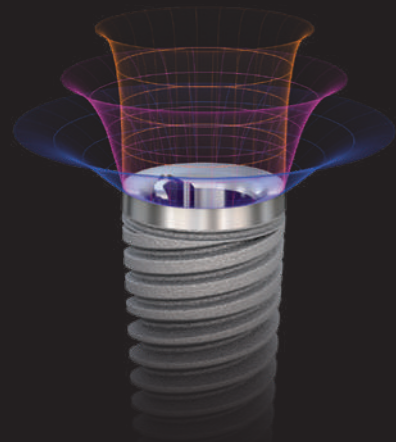

Esthetics

- + 100% patient-individual emergence profile
- + Concave & pink anodized implant shoulder for soft tissue design
- + Natural colour with zirconia directly on the implant



Immediacy

- + Immediate full digital local workflow (chairside or labside)
- + TRI+ connection to all open digital workflows for chairside & labside milling

Simplicity

- + Faster Workflow and increased precision by 73% due to no abutment, no cement, no model and no analog
- + No limits in materials, indications and angulations (up to 100° between implants)
- + Significant material and cost savings



Performance

- + Strong like an abutment
- + Higher precision
- + No cement: 100% screw retained restoration, eliminating the risk of periimplantitis

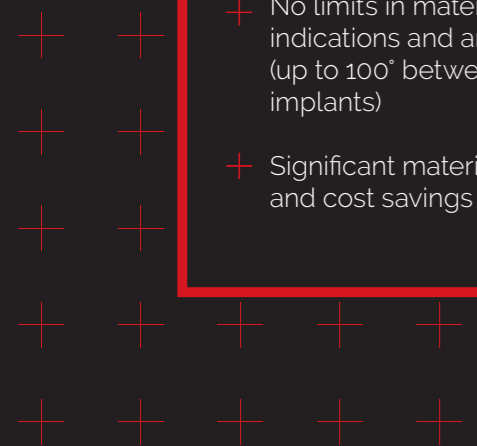
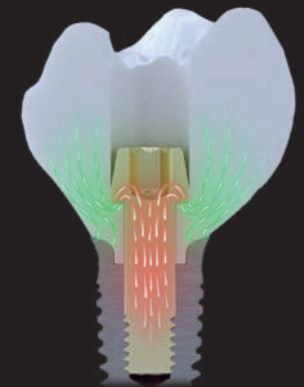

INCLUDED
WITH EVERY
matrix[®]
IMPLANT

8

INTEGRATED APPS FOR YOUR DIGITAL WORKFLOW



Scan&Smile



DHC Library



ScanBridge



Guided Surgery



Tooth-in-a-Box



Lab Design



Lab Milling



LMS



SCAN&Smile

The Fastest & Simplest Implant Smile

P. 8



**TRI[®]
DIGITAL HEALING
COLLAR LIBRARY**

Individual healing for every patient

P. 9



**TRI[®]
SCAN BRIDGE**

The Ultimate Digital Scanning Experience

P. 10

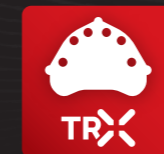

TRX GUIDED SURGERY

Empower your precision with TRX Guided Surgery

P. 11



SCAN & Smile IN ONE HOUR



THE FASTEST & SIMPLEST IMPLANT SMILE

Power your patient visits with the Scan & Smile Solution by TRI®. The **matrix**® implant system in combination with 3D printing technology simplifies the immediate and chairside process. Scan & Smile allows you to place & scan the implant and print & insert the provisional crown in **less than 1 hour**.



BOOK DESIGN SERVICE

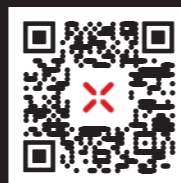

TRI® DIGITAL HEALING COLLAR LIBRARY



INDIVIDUAL HEALING FOR EVERY PATIENT

TRI® is expanding its **matrix**® implant line portfolio with the first ever digital healing collar library. The digital healing collar library for the **matrix**® implant system allows to choose from 48 individual healing components based on the biological tooth shape.

Soft tissue management made easy by choosing a design in the CAD software and adding a personal touch based on the patient factors.

- No CAD design needed
- Individual tissue healing
- Cost efficiency no abutment needed
- Print Chairside

TRI[®] SCAN BRIDGE



TRX GUIDED SURGERY

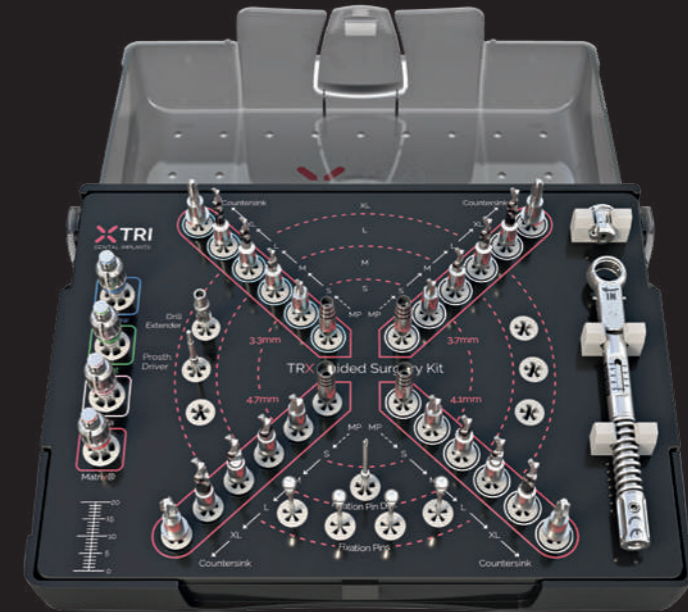
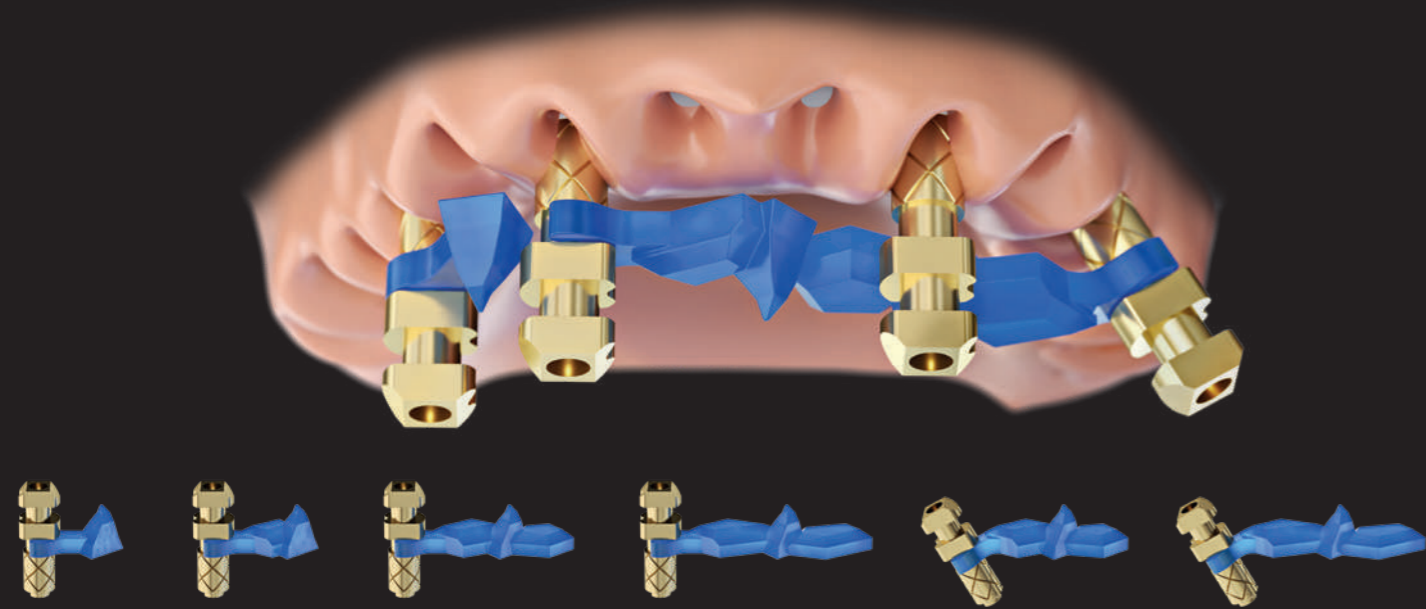

THE ULTIMATE DIGITAL SCANNING EXPERIENCE

The **matrix[®]** Scanbridge Technology provides a high-precision, cost-effective solution for full-arch scanning of the edentulous patient. Its simple design and easy click mechanism allows for easy handling and scanning of both implant position and soft tissue with one scan in only 20 seconds. The Scanbridge can be printed locally, saving cost and time.

It is compatible with all IOS scanners and available in different lengths and angulations, making it a versatile and seamless addition to any workflow.

EMPOWER YOUR PRECISION WITH TRX

TRX Guided Surgery offers a radically reduced workflow with an unmatched precision due to the sharp cutting properties of the drills. Enjoy the highest level of precision, even in challenging cases, with TRX's lateral cutting abilities and patented 2-level depth stop.

With its simple and unique design, color-coding, and compatibility with major software providers, TRX is the ultimate solution for seamless and precise dental surgery.



Highest precision for full-arch scanning



Full-arch scan in 20 seconds



Compatible with all IOS Scanners & no installation needed



Print Chairside



Highest precision



Minimal portfolio of instruments



Fast surgical procedure & handling for staff



Compatible with all major software

DISCOVER THE **UNIQUE FEATURES** OF THE **matrix[®]** **IMPLANT SYSTEM**

matrix[®] SmartBolt
made to support all materials
P. 17

matrix[®] MillFit
designed to be milled locally
P. 16

matrix[®] ProFlex
allows implant placement
and screw channel freedom
P. 20

matrix[®] SlimNeck
for increased biological width
P. 18

matrix[®] SmartLock
for engaging and
non-engaging restorations
P. 15

matrix[®] PowerBase
designed for Zirconia on Titanium
P. 14

matrix[®] PowerBase

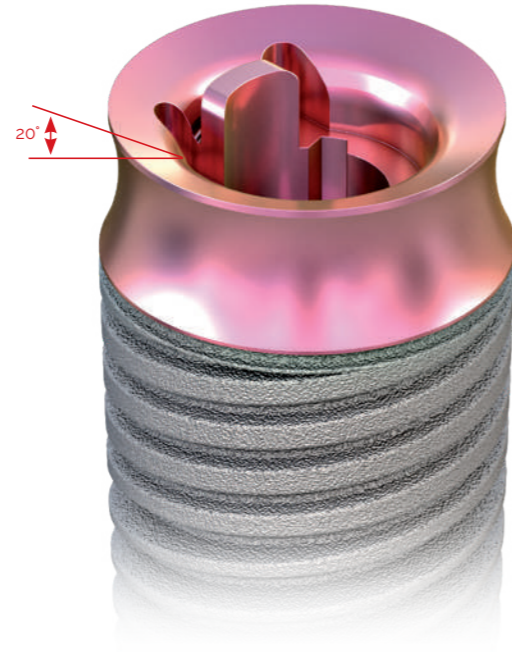

A WORLD-CLASS CONNECTION DESIGNED TO SUPPORT ZIRCONIA ON TITANIUM

matrix[®] PowerBase and its 20° degree internal flat connection, maximizes the surface area to support prosthetic restoration directly on the implant. The world-class connection provides self-centering properties for ideal handling and fit and allows high divergences (50°) between implants.



Platforms P37 and P45 with significantly larger area than a Ti-Base



Optimal for force transmission between implant and crown



Support direct restoration with all materials



Multi-Level P37 (ø3.7mm)



Multi-Level P45 (ø4.5mm)



Bone-Level P37 (ø3.7mm)



Bone-Level P45 (ø4.5mm)

matrix[®] SmartLock

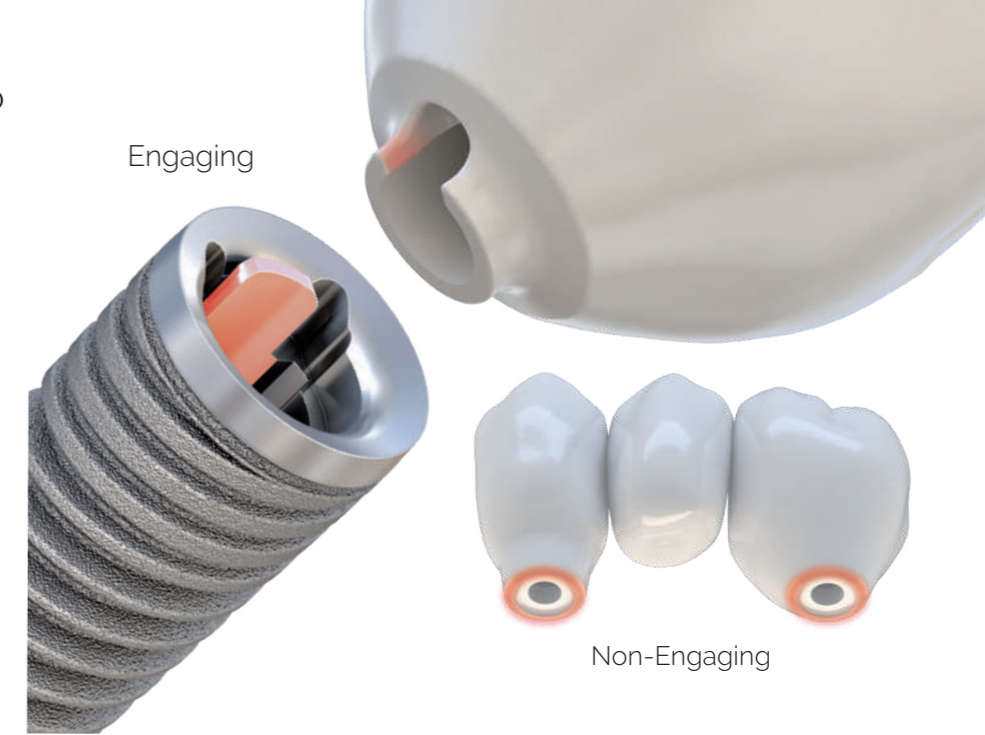

A VERSATILE CONNECTION FOR ENGAGING AND NON-ENGAGING RESTORATIONS

matrix[®] SmartLock is a self-locking system for automatic positioning, which allows only one single position for crowns and a non-engaging position for multi-unit restorations. It consists of two big vertical rotation blockers with 1.2mm distance for easy milling of the prosthetics and tactile feedback.



Highly precise fit through vertical guidance



Self-locking system for automatic positioning (one position)



Allows for engaging as well as non-engaging connections based on milling strategy.

matrix[®] MillFit

Dedicated milling strategy for matrix[®] connection.



matrix[®] SmartBolt

Titanium

2.25mm



flat horizontal screw head

Zirconia and Polymers
(for angulated screw channel only)

2.6mm



flat horizontal screw head

Zirconia and Polymers

2.8mm

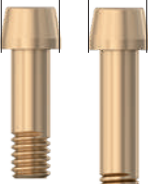

flat horizontal screw head

CONNECTION DESIGNED FOR EASY AND HIGHLY PRECISE LOCAL MILLING

matrix[®] MillingFit achieves easy and precise milling with standard tools through dedicated milling strategies. A compact connection between implant, screw and crown with no hollow spaces and an interface surface roughness which rises above industrial abutment manufacturing.



Standard drills and dedicated CAM strategies for matrix[®]



Achieves 0.2μ of surface roughness for all materials



Better than industrial abutment manufacturing (Ra 0.6 μ)

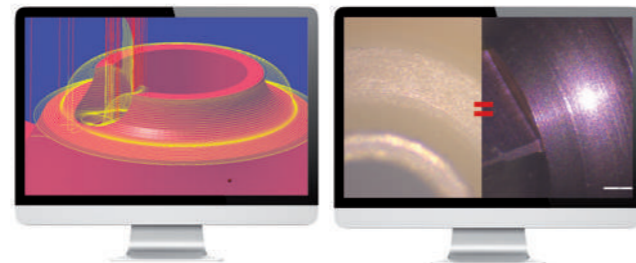

INTELLIGENT SCREW SYSTEM FOR ALL MATERIALS AND INDICATIONS

matrix[®] SmartBolt consists of three different screw heads, designed for material-specific milling strategies to ensure a precise fit. The specially treated screw surface guarantees increased hardness, scratch-resistance and fatigue strength. The sterile screws are gold anodized for higher esthetics with translucency zirconia.



Standard drills and dedicated CAM strategies for matrix[®]



Achieves 0.2μ of surface roughness for all materials



Better than industrial abutment manufacturing (Ra 0.6 μ)

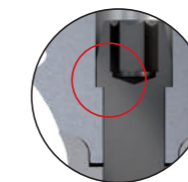

Metals
Narrow screw-head for metal restorations to minimize diameter of screw-access hole

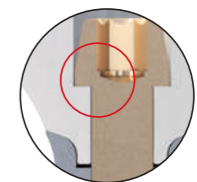

Ceramics
Medium-size screw-head optimized to support zirconium.

PROFILES FOR INCREASED BIOLOGICAL WIDTH



Concave Multi-Level emergence profile for infinitely more esthetics

The **matrix**[®] multi-level implant comes with a modern emergence profile and a unique concave design. The implant line features a pink anodized neck for optimized translucency and supports modern surgical procedures, such as sub-crestal placements. Ideal for minimal invasive procedures and an increased biological width, **matrix**[®] is better than ever in guaranteeing high esthetic results and longevity.

Bone-Level platform switching

The **matrix**[®] bone-level implant features a 20° shoulder for high divergence bridge restorations and integrates platform-switching to preserve the crestal bone.

Multi-Level

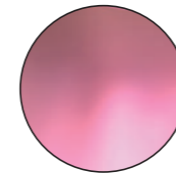

Pink anodization for tissue management

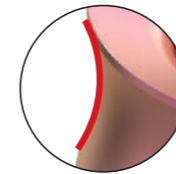

Concave design for increased biological width

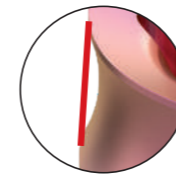

Thanks to reverse-taper design bone doesn't get re-exposed

Bone-Level

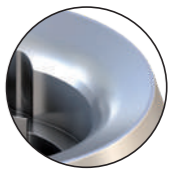

The 20-degree shoulder for high divergence bridge restorations

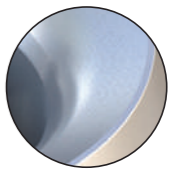

Platform switching for stable crestal bone levels.

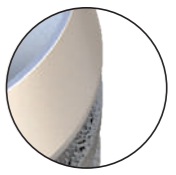

0,5mm machined neck in the crestal area.



matrix[®] ProFlex

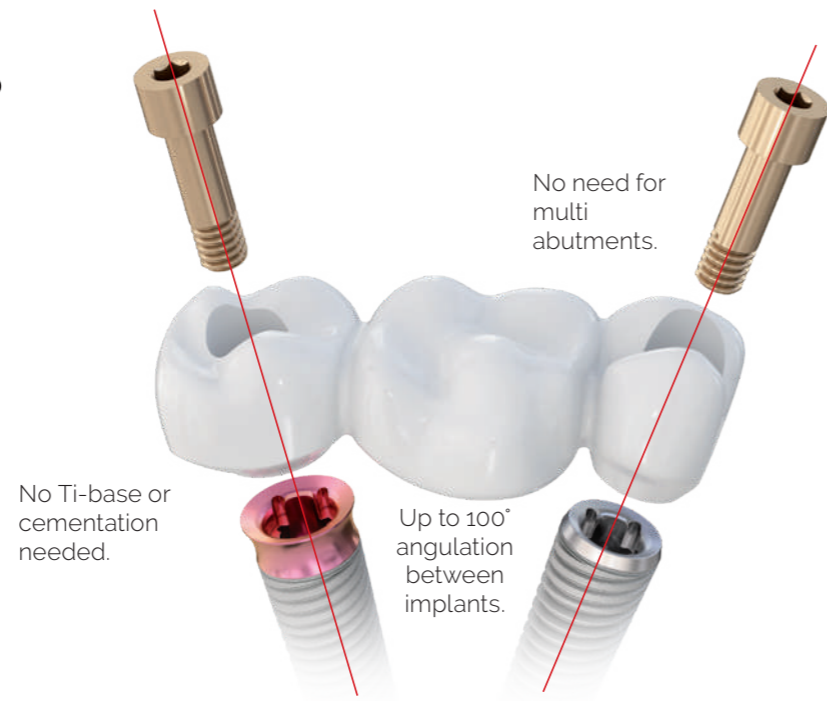

HIGHEST DESIGN FLEXIBILITY IN LOCAL PRODUCTION

matrix[®] ProFlex allows implant divergence up to 100° and 30° angled screw channels. The compact design facilitates the placement of fully anatomical crowns without adjustment and supports easy impression taking for angulated implants.

- + Screw channel up to 30° degree angulation all around
- + Occlusal esthetics in anterior region
- + Better handling in posterior region

Allows implant divergence up to 100° and 30° angled screw channels.



PATIENT-SPECIFIC & INDIVIDUAL EMERGENCE PROFILE

Same emergence profile for healing, provisional and final restoration.

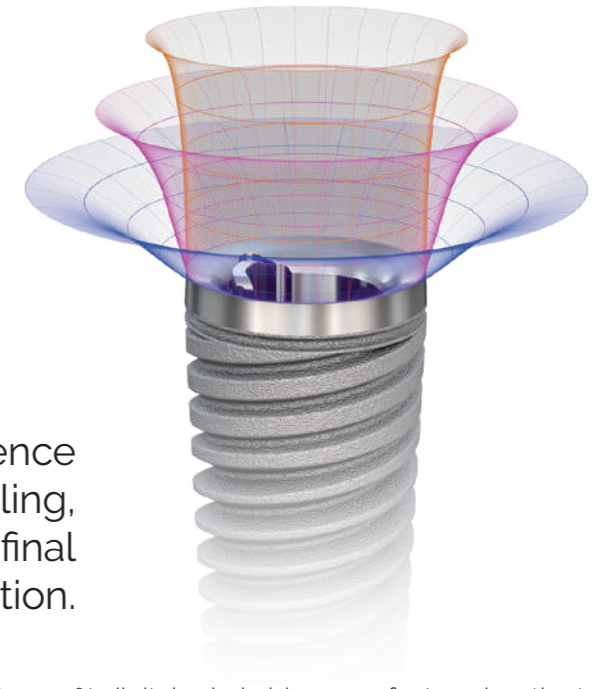

matrix[®] allows to create 100% digital, chairside manufactured patient-specific emergence profiles by considering the biological shape and transferring the design 1:1 throughout the whole treatment process (healing, provisional and final restoration). With matrix[®] any design and shape on any material is possible and guarantees a full-anatomic and high esthetic gingiva management.

- + Production of personalized healing collar from any material
- + Immediate and efficient through chairside manufacturing option
- + High esthetic gingiva management

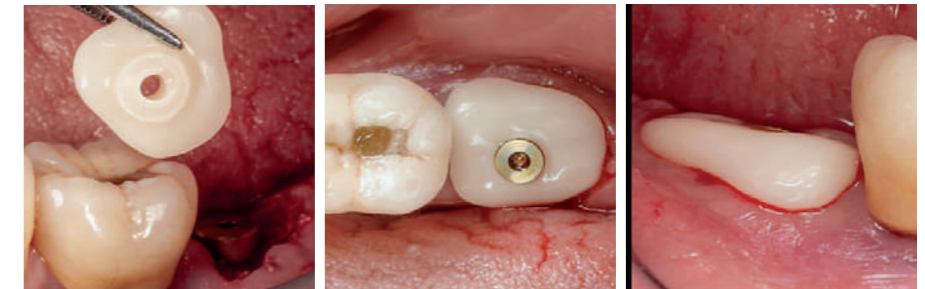

Dr. Ramón Gómez Meda (Spain)

matrix[®] CASE BOOK VOL. 4

3-year follow-ups & new cases

INCLUDING CASES BY:

matrix[®] CLINICAL DATA



Prof. Ronald Jung



Dr. Ramón Gómez Meda



Dr. Stavros Pelekanos

AND MANY MORE

DOWNLOAD THE matrix[®] CASE BOOK



DOWNLOAD THE matrix[®] SCIENTIFIC SUMMARY WITH ALL PRE-CLINICAL AND CLINICAL EVIDENCE

matrix[®] SCIENTIFIC WHITE-PAPER

PMCF matrix[®] Survey on the Performance and Usability of 2334 matrix[®] implants after 2.5 years

2.5 YEARS RESULTS

Study executed by renowned and independent AMR-CRO Clinical Research Organisation. **AMR** ASSOCIATED MEDICAL RESEARCH

Study Set-up:
matrix[®] is a dental implant which is CE and FDA approved for fully digitally single and multi-unit restorations directly on the implant without the use of an abutment. TRI[®] obtained CE marking in October 2020. This survey was conducted in December 2022. This survey aimed to document the clinical performance of matrix[®] among the TRI[®] lead user group after 27 months since first implants installed.

Prof. Ronald Jung **Prof. Tomas Linkevicius** **Dr. Ramón Gómez Meda** **Dr. Andreea Alessandro Agrini** **Dr. Alexandru Ionescu** **Dr. Ivan Peev** **Dr. Joel Toles** **Prof. Constantin von See** **Dr. Marco Zellner**

- Total number of 2334 matrix[®] implants placed.
- 100% successful osseointegration achieved.
- 10% improvement of bone levels, 72.5% stable crestal bone levels, 0% bone loss greater than 1mm.
- 99.7% OVERALL SUCCESS RATE
- 7/8 participants report better clinical results with matrix[®] compared to abutments.

CONCLUSION:
2334 matrix[®] implants have been placed by the lead users since October 2020. A 99.7% success rate was achieved. Therefore, the study concludes that the matrix[®] implants can be considered safe.

Learn more on www.triswiss.com

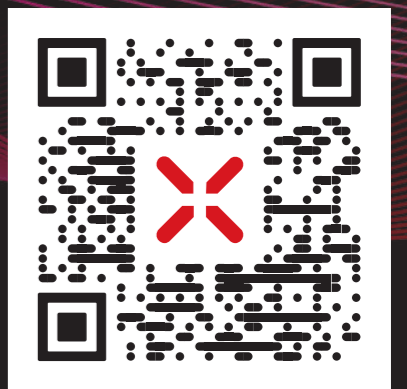



TRI Dental Implants Int. AG
Switzerland
Infoline Europe: 00800 3313 3313
Infoline USA: (636) 486-7334
www.tri.swiss



TRI® Dental Implants, the TRI® Dental Implants logotype and all other trademarks used in this document are, if nothing else is stated or is evident from the context in a certain case, trademarks of the TRI Dental Implants Int. AG.
TRI® **matri**x® Introduction Brochure EN 2023-11

CE 0297 | FDA Registered

